

QUALITY IN EVERY CLASS

THE NEW GENERATION

**BDS MASCHINEN
MADE IN GERMANY**

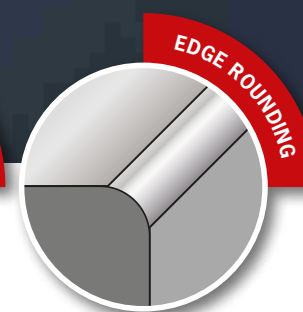
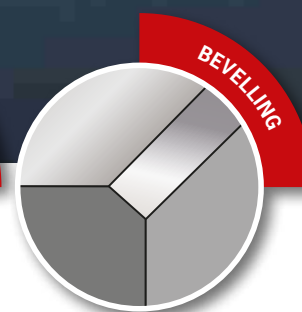
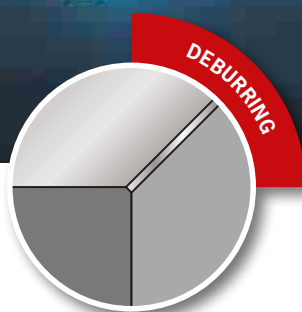

BEVELLING AND CHAMFERING MACHINES

Edition 2019

BDS
MASCHINEN

Next-generation BDS Beveling & Chamfering Machines

STATE OF THE ART

REDEFINED

**Series
EKF 300**



**Series
EKF 600**

**Series
EKF 500**

The new BDS Series of Beveling Machines are tailor made to meet the requirements of every operator. With the current addition of 4 new Chamfering & Deburring machines, the EKF series now consists of 3 performance categories namely, EKF 300, 400 & 500 Series. They deliver optimal results in a short amount of time, be it machining metal components made of steel, stainless steel, non-ferrous metals, brass or even synthetic materials. All machines can produce internal and external radii.

The new milling technology from BDS produces the best results with comfortable handling

The new tangential plate configuration on the milling heads ensures low-impact and low-vibration machining even at lower speeds. A wide range of materials can be machined easily with the variable speed control & full wave control electronics in combination with the strong motor output. The new inserts with four cutting edges also make machining easier.

- ▶ Normal steel
- ▶ Aluminium
- ▶ Stainless steel
- ▶ Non-ferrous metal

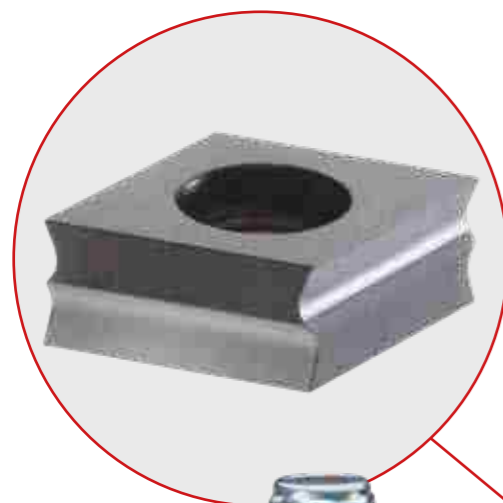

ROTATING MILLING DISC

A new gear mechanism redesigned especially for the new EKF series delivers maximum stability.

The double bearing in the working spindle – angular ball bearings in tandem – ensures precise concentricity and stability. The rotary disc with recirculating bearings reduces friction resistance and energy consumption.

- ▶ New, unique tangential plate configuration
- ▶ No impact jarring when operating at low speeds
- ▶ Clean milled edges, even in internal and external radii
- ▶ Ideal for weld seam preparation



Sharp outer edges

Consistent machining of internal radii

Even milling when rounding

Our edges are clear.

BDS incorporates new technology with no compromises, for milled edges of outstanding quality in many applications:

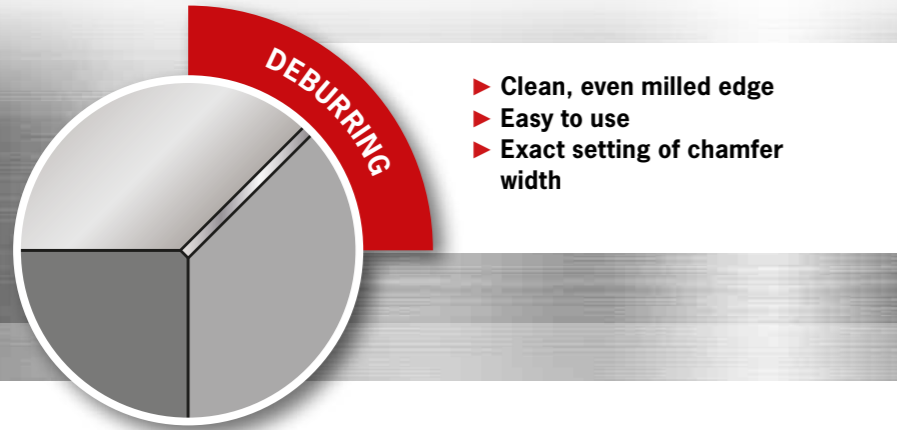

- ▶ Clean, even milled edge
- ▶ Easy to use
- ▶ Exact setting of chamfer width

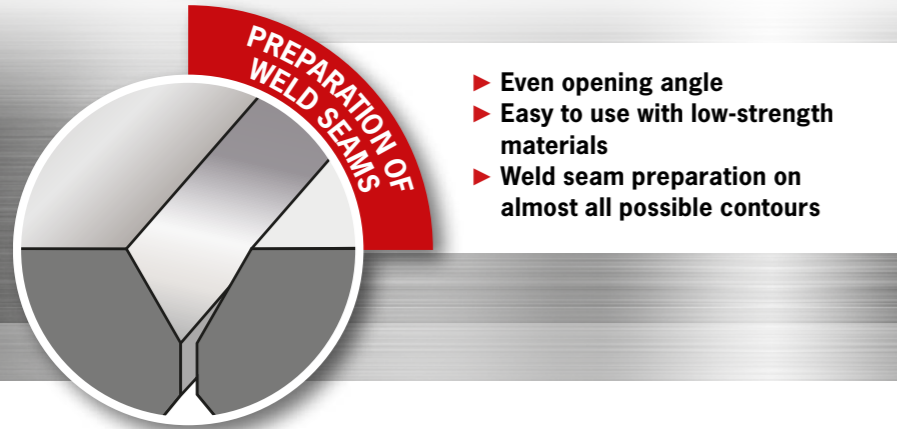

- ▶ Even opening angle
- ▶ Easy to use with low-strength materials
- ▶ Weld seam preparation on almost all possible contours

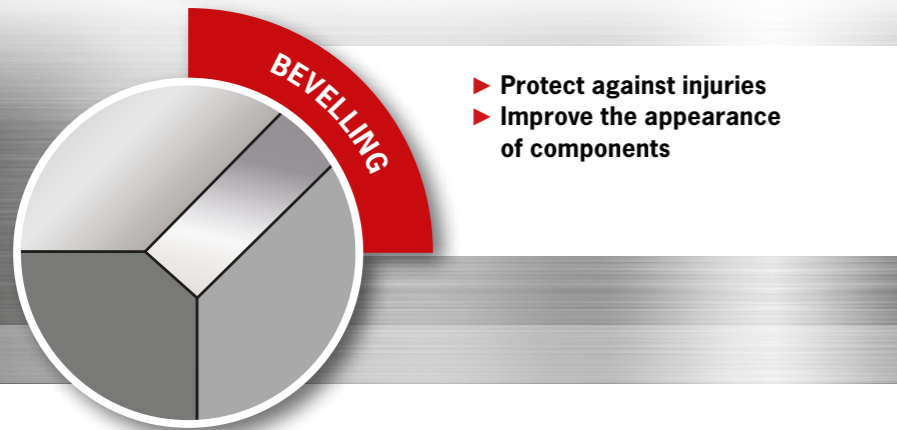

- ▶ Protect against injuries
- ▶ Improve the appearance of components

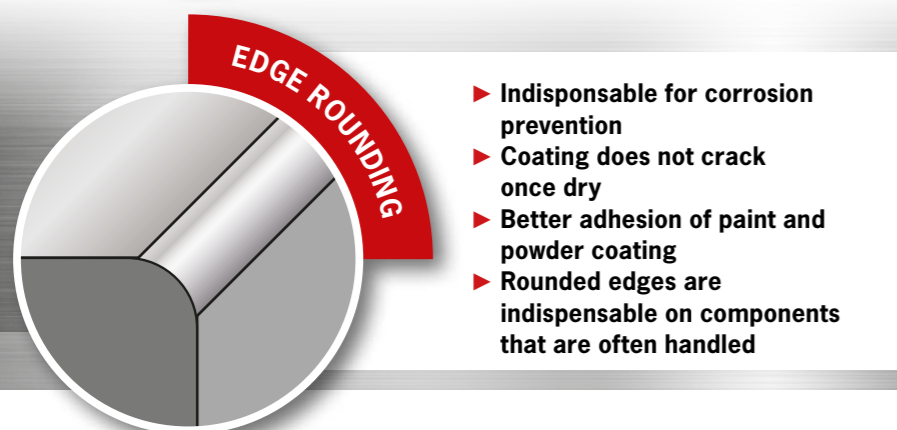

- ▶ Indispensable for corrosion prevention
- ▶ Coating does not crack once dry
- ▶ Better adhesion of paint and powder coating
- ▶ Rounded edges are indispensable on components that are often handled



EKF 300 Series

The best entry-level series for professional chamfering & deburring operations.

THE HANDY ALL-ROUNDER



Technical data	EKF 300	EKF 450	EKF 452
Chamfer angle	30°	45°	Radius 2.5 mm
Chamfer width	0–5 mm	0–6 mm	Radius 2.5 mm
Cutter type	ZFR 300.3	ZFR 450.3	ZFR 452.3
Milling tool	Screw-in milling cutter with three carbide inserts		
Dimensions (LxBxH)	310 × 295 × 138 mm		
Approx. net weight	4.6 kg	4.6 kg	4.6 kg
Voltage (see nameplate)	220–240 V/50–60 Hz and 110–125 V/50–60 Hz		
Motor output	1500 W	1500 W	1500 W
Speed	6000 rpm	6000 rpm	6000 rpm
Feed	Manual	Manual	Manual
Protection type	IP 20	IP 20	IP 20

Scope of delivery	EKF 300	EKF 450	EKF 452
Machine	EKF 300	EKF 450	EKF 452
Milling cutter	ZFR 300.3	ZFR 450.3	ZFR 452.3
Carbide inserts	SHM 200	SHM 200	SHM 202
Hook wrench	34/36	34/36	34/36
Torx screwdriver	TX 9	TX 9	TX 9
Spanner	SW 22	SW 22	SW 22
Carry case	✓	✓	✓
Operating instructions	✓	✓	✓
Warranty card	✓	✓	✓

Other optional accessories are available on page 11

EKF 500 & EKF 600 Series

The high end top of the line series.
Compact series with variable speed & full wave control electronics.

FULL POWER AHEAD

VARIABLE SPEED CONTROL

NEW MILLING TECHNOLOGY

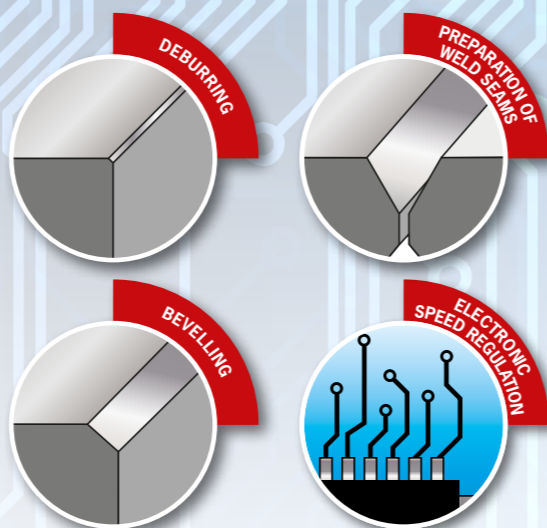

- ▶ Variable speed control
- ▶ Carbide inserts with four cutting edges
- ▶ New ergonomic design
- ▶ Revolving supporting disc
- ▶ Fore beveling normal steel, stainless steel, aluminium and non-ferrous metal

The new EKF 500 & 600 series from BDS is designed for maximum performance and optimal comfort. With the new milling head technology, the EKF machines can also operate at low speeds without jerking or jumping. The result is optimally milled edges, even when rounding. The EKF machines are ideal for deburring, beveling and weld seam preparation.

EKF 530
EKF 545

**1800
Watt**

EKF 630
EKF 645

**2300
Watt**

High motor output

Electronic control

Technical data	EKF 530	EKF 545	EKF 630	EKF 645
Chamfer angle	30°	45°	30°	45°
Chamfer width	0–12 mm	0–12 mm	0–15 mm	0–15 mm
Cutter type	ZFR 530	ZFR 545	ZFR 630	ZFR 645
Milling tool	Screw-in milling cutter with six carbide inserts		Screw-in milling cutter with ten carbide inserts	
Dimensions (LxBxH)	375 × 350 × 300 mm		400 × 350 × 300 mm	
Approx. net weight	9.3 kg	9.3 kg	10.2 kg	10.2 kg
Voltage (see nameplate)	220–240 V/50–60 Hz and 110–125 V/50–60 Hz		220–240 V/50–60 Hz and 110–125 V/50–60 Hz	
Motor output	1800 W	1800 W	2300 W	2300 W
Speed	Seamless electronic speed regulation 1850–3350 rpm with full wave control electronics		Seamless electronic speed regulation 1600–3000 rpm with full wave control electronics	
Feed	Manual	Manual	Manual	Manual
Protection type	IP 20	IP 20	IP 20	IP 20

Scope of delivery	EKF 530	EKF 545	EKF 630	EKF 645
Machine	EKF 530	EKF 545	EKF 630	EKF 645
Milling cutter	ZFR 530	ZFR 545	ZFR 630	ZFR 645
Carbide inserts (Quantity)	SHM 900 (6)	SHM 900 (6)	SHM 900 (10)	SHM 900 (10)
Hook wrench (C)	45/50	52/55	52/55	58/62
Screwdriver (Torx) (B)	TX 15	TX 15	TX 15	TX 15
Spanner (A)	SW 22	SW 22	SW 22	SW 22
Carry case	✓	✓	✓	✓
Operating instructions	✓	✓	✓	✓
Warranty card	✓	✓	✓	✓

Other optional accessories are available on page 11



45° and 30° milling angles

Milling head with ten carbide inserts (EKF 600 series)

AutoCUT 500

Fully automatic feed plate beveling machine.

PERFECT

WELD SEAMS

AUTOMATICALLY

Weld seam milling with automatic, seamlessly adjustable feed: quick, flexible and with a variable milling angle. The inlet/outlet rails make it exceptionally easy and safe to handle the AutoCUT 500.

The milling angle can be adjusted seamlessly between 15° and 60°.

- ▶ **Simple, safe handling**
- ▶ **No restriction of the working length**
- ▶ **No guiding carriage is needed, therefore independent from the ground conditions**
- ▶ **For milling plate thicknesses from 10 mm to 40 mm**
- ▶ **Milling cutter with 6 carbide inserts**

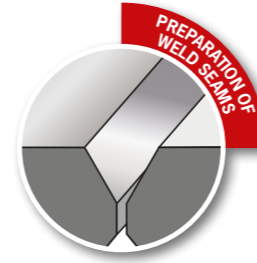

Technical data	AutoCUT 500
Chamfer angle	15°–60° seamless
Chamfer width	max. 30 mm
Cutter type	ZFR 500
Milling tool	Arbor milling cutter with six carbide inserts
Dimensions (LxBxH)	600 × 500 × 540 mm
Approx. net weight	50 kg
Voltage (see nameplate)	380 V
Motor output	1.1 kW
Speed	2750 rpm
Feed	Automatic and smoothly adjustable
Protection type	IP 20

Scope of delivery
1 AutoCUT 500
1 Arbor milling cutter with six SHM 400 carbide inserts
1 Operating manual
1 inlet and 1 outlet rail
1 SW 22 spanner
1 SW5 screwdriver with T-handle
1 SW6, SW8 and SW10 offset screwdriver
1 TX 15 screwdriver

Other optional accessories are available on page 11



Chamfer width up to 30 mm



Inlet/outlet rails of the AutoCUT 500

Accessories:
Carbide insert
SHM 400



Accessories:
Milling cutter ZFR 500

Precise
guidance system

Exact setting of feed rate
with the seamlessly adjust-
able feed unit

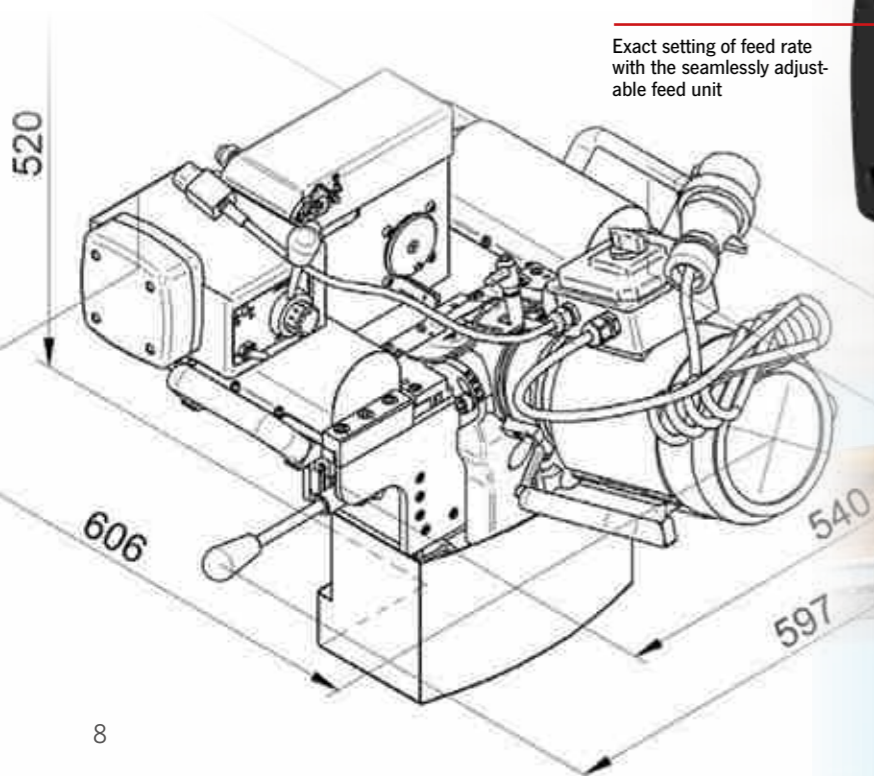

SKF 25

For quick and easy preparation of weld seams

COMPACT, UNIVERSAL

BEVELING

MACHINE

Weighing 22 kg, the SKF 25 beveling machine is easy to handle and precise to guide with smooth rollers. The result is evenly milled edges for perfect weld seams.

- ▶ Chamfer width up to 15 mm
- ▶ Seamless angle adjustment from 15° to 60°
- ▶ With ergonomic handle
- ▶ Easily guided with guide rollers
- ▶ For beveling normal steel, aluminium and non-ferrous metal



Seamless angle adjustment from 15° to 60°



Edge machining on vertical pipes



PREPARATION OF WELD SEAMS



Accessories:
Carbide insert



Accessories: ZFR 250 arbor milling cutter

Technical data

SKF 25

Chamfer angle	15°–60° seamless
Chamfer width	15 mm
Cutter type	ZFR 250
Milling tool	Arbor milling cutter with ten carbide inserts
Dimensions (LxBxH)	365 × 455 × 270 mm
Approx. net weight	22 kg
Voltage (see nameplate)	220–240 V/50–60 Hz and 110–125 V/50–60 Hz
Motor output	1.1 kW
Speed	2850 rpm
Feed	Manual
Protection type	IP 20

Scope of delivery

- 1 SKF 25
 - 1 Carry case
 - 1 ZFR 250 arbor milling cutter with ten SHM 800 carbide inserts
 - 1 SW 8 offset screwdriver
 - 1 TX 15 screwdriver
- Other optional accessories are available on page 11

BDS accessories

The original is the best

Machine	Milling cutter	Insert	Name
EKF 300.3	ZFR 300.3	SHM 200 SHM 200-E	Standard carbide insert Carbide insert with VarioPlus coating
EKF 450.3	ZFR 450.3	SHM 200 SHM 200-E	Standard carbide insert Carbide insert for stainless steel
EKF 452.3	ZFR 452.3	SHM 202 SHM 201 SHM 200	Carbide insert for EKF 452 r=2.5 mm Carbide insert for EKF 452 r=1.5 mm Standard carbide insert
EKF 530	ZFR 530	SHM 900 SHM 900-E	Standard carbide insert Carbide insert for stainless steel
EKF 545	ZFR 545	SHM 900 SHM 900-E	Standard carbide insert Carbide insert for stainless steel
EKF 630	ZFR 630	SHM 900 SHM 900-E	Standard carbide insert Carbide insert for stainless steel
EKF 645	ZFR 645	SHM 900 SHM 900-E	Standard carbide insert Carbide insert for stainless steel
AutoCUT 500	ZFR 500	SHM 400 SHM 400-E	Standard carbide insert Carbide insert for stainless steel
SKF 025	ZFR 250	SHM 800	Standard carbide insert

All milling tools are supplied with clamping screws and WITHOUT carbide inserts! Please expressly include these in your order.

Accessories:
HM Carbide insert SHM 200-E



Accessories:
HM Carbide insert SHM 202



Accessories:
HM Carbide insert SHM 900



Accessories:
HM Carbide insert SHM 400



Accessories:
HM Carbide insert SHM 800



EKF guide plate

The guide plate ensures that EKF milling machines are positioned and guided safely

Reliably prevents the machine from tilting or slipping while being positioned. This is an accessory you should not do without.

Name

ZFP 100



A simple yet highly useful solution:
The guide plate is connected to a clamp and affixes to the workpiece, ensuring that the edge is fed in smoothly.

Accessories: Milling cutter



Milling cutter ZFR 300/450.3



Milling cutter ZFR 452.3



Milling cutter ZFR 530/545



Milling cutter ZFR 630/645



Milling cutter ZFR 500



Milling cutter ZFR 250

DO YOU HAVE ANY QUESTIONS? WE HAVE THE ANSWERS!

Contact us in person, on the web or via the app, from wherever you want.



Subject to technical changes. Reprinting this document, in part or in full, is only permitted with written consent from BDS Maschinen GmbH, Mönchengladbach. Errors and omissions excepted. All prices exclude VAT. Version EN 2019. Printed in Germany

BDSMASCHINEN
MADE IN GERMANY

BDS
MASCHINEN

BDS Maschinen GmbH
Martinstraße 108
D-41063 Mönchengladbach
Phone +49(0)2161/35 46-19
Fax +49(0)2161/35 46-15
www.bds-maschinen.de
export@bds-maschinen.de

